

1. SCOPE OF THE PAPER

We begin by giving intuitive definitions of our terms. Start out with a game, either in extensive or in normal form. The game becomes *cooperative* if we allow the players to communicate before each play and to make binding agreements about the strategies they will use (either mixed or pure). We say that *side payments* are allowed if there is a common medium of exchange, such as money, which can be transferred between the players before or after the play. We say that *utility is transferable* if the increment to the payoff of a player caused by a transfer of money is proportional to the amount of money transferred [33]. The classical theory of n -person games as first conceived by von Neumann and Morgenstern [45], and later elaborated upon by many other writers, is concerned exclusively with cooperative games in which side payments are allowed and utility is transferable. It is commonly assumed that this involves an interpersonal comparison of utility, but this is false; it is only necessary that each individual's utility be an increasing linear function of money, and nothing need be said about the constant of proportionality (indeed any statement about the constant of proportionality is meaningless within the framework of N-M¹ utility theory). However, it is true that mathematically, N-M games can be treated as if the payoff were in money rather than in utility.

It is also often assumed that the N-M theory and its subsequent elaborations depend in an essential way on side payments and transferable utility; this is also false, as is shown by the small but growing body of recent work which parallels the N-M theory but deals with cooperative games in which side payments are either altogether forbidden, or are allowed but utility is not transferable. It is this body of work that I wish to survey here. Incidentally, recall that noncooperative games include cooperative games as a special case, cooperative games without side payments include cooperative games with side payments, and the case of transferable utility is the most special of all. Cooperative games without side payments and cooperative games with side payments but without transferable utility present many of the same problems, and since the former are more general we restrict much of our discussion to them.

Revised version of a lecture delivered at the Princeton Conference on Recent Advances in Game Theory, October 1961.

¹ von Neumann—Morgenstern.

This chapter originally appeared in *Essays in Mathematical Economics in Honor of Oskar Morgenstern*, edited by M. Shubik, pp. 3–27, Princeton University Press, Princeton, 1967. Reprinted with permission.

2. MOTIVATION

Cooperative games without side payments are of considerable importance in the applications. In some situations side payments are impossible because there is no common medium of exchange, or such a medium, if it exists, is irrelevant; think of the international situation. In other cases side payments are called bribes and are ruled out for ethical or legal reasons, while cooperation is considered perfectly all right. Finally, even when side payments are legal, utility usually is nonlinear in money, and this may result in a situation which is not covered by the N-M theory. It is this last fact that caused Luce and Raiffa to state that the N-M theory is "for many purposes next to useless" [19, p. 233]. We do not share this view, because if money is substituted for utility the N-M theory still applies to any situation in which probabilistic considerations are considered irrelevant;² but we do feel that an extension of the N-M theory to the no-side-payment case is useful.

3. THE CHARACTERISTIC FUNCTION

Let us now begin with a description of some of the work that has been done in this field. There are three widely used models for studying n -person games: the extensive form, the normal form, and the characteristic function.

The *extensive* form is essentially a mathematical representation of the rules of the game. The *normal* form is the "payoff matrix"—a list of strategies for each player, together with a payoff vector for each n -tuple of strategies. The *characteristic function* gives for each coalition the set of payoff vectors that that coalition can "assure" its players. There are, of course, connections between the various forms; the normal form can be calculated from the extensive form, and the characteristic function from the normal form. However, each form is suited for different kinds of investigations. We will begin our study of cooperative games without side payments with the characteristic function.

Let us represent the payoff to each player by a coordinate of Euclidean space; thus we will be working in Euclidean space of dimension equal to the number of players, and in its subspaces. We denote by N the set of players, by E^N the Euclidean space in which we are working, and by E^S the subspace of E^N spanned by the axes belonging to the players in a subset S of N . Points of E^N are called *payoff vectors*, of E^S *payoff S -vectors*. The *characteristic function* associates with each $S \subset N$ a subset $v(S)$ of E^S . Intuitively, $v(S)$ represents the set of payoffs that S can assure itself. When side payments are allowed and utility is transferable (this will henceforth be called

² Even when they are relevant the N-M theory applies in a much wider range of situations than has often been supposed; see §8.

the N-M case), $v(S)$ is the closed half-space

$$\left\{x \in E^S : \sum_{i \in S} x^i \leq f(S)\right\},$$

where $f(S)$ is the N-M characteristic function (i.e., the total amount of money that S can assure itself). A typical such half-space is illustrated in Figure 1 for the 2-player case; $v(S)$ is the whole area to the "southwest" of the line $x^1 + x^2 = f(S)$.

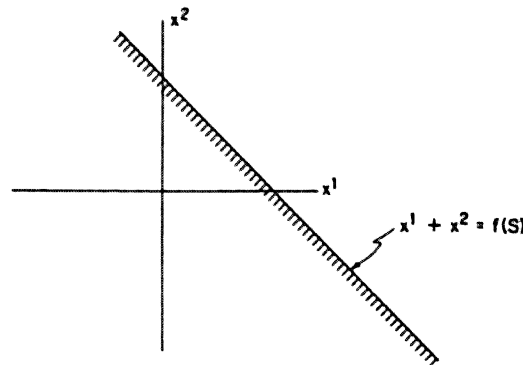

FIGURE 1

Returning to the no-side-payment case, we assume the following conditions for our characteristic function:

$$v(S) \text{ is convex, closed, and non-empty.} \quad (1)$$

$$x \in v(S), y \in E^S, x \geq y \Rightarrow y \in v(S). \quad (2)$$

$$v(S \cup T) \supseteq v(S) \times v(T) \text{ for } S \text{ and } T \text{ disjoint.} \quad (3)$$

The vector inequality in (2), like all subsequent vector inequalities, is meant to hold for each coordinate.

Intuitively, convexity follows from the fact that players can mix and correlate their strategies. Closedness is mainly a question of mathematical convenience and is satisfied in all applications that I can think of. Condition (2) says that if a coalition can assure itself of a payoff vector x , it can also assure itself of anything coordinate-wise less. The last condition is superadditivity; any vector whose components can be obtained by each of two disjoint coalitions acting separately can also be obtained by them when acting together. In Figure 2 we show a typical set of the form $v(S)$ in two dimensions.

We have defined a characteristic function; in order to define a *game in characteristic function form*, we need an additional concept that is not needed in the N-M theory. This is the set H of outcomes that "can actually occur." H has a very close connection with $v(N)$: its "top" coincides with

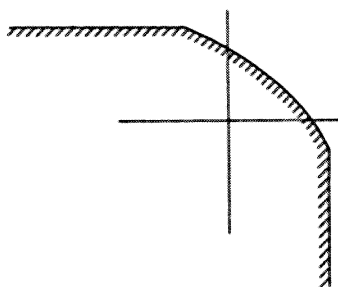

FIGURE 2

the “top” of $v(N)$ (see Figure 3), or in precise terms

$$v(N) = \{x \in E^N : \exists y \in H \text{ such that } y \geq x\}. \quad (4)$$

The difference between $v(N)$ and H is that $v(N)$ consists of those vectors x that N can “guarantee,” in the sense that it can get *at least* x ; whereas H is the set of vectors such that N can get *exactly* x .

Summing up, a game in *characteristic function form* is a pair (v, H) , where v is a characteristic function obeying (1), (2), and (3), and H is a convex proper subset of E^N satisfying (4).

Sometimes it will be assumed that H is a convex compact polyhedron; this is justified if one thinks of the game in characteristic function form as being generated from a finite game in normal form. On other occasions, it is more convenient to assume that $H = v(N)$; this is justified, for example, if one makes an assumption of “free disposal.” The latter assumption is the one more suited to the N-M case.

The set of conditions ((1) through (4)) that we have assumed for v and H is by no means the only possible one, and in fact almost every paper on the subject uses a different variant of the set of assumptions. In particular, for many purposes super-additivity (3) is unnecessary, sometimes convexity is not needed either, and for other purposes condition (4) is unnecessary. The conditions given here have been chosen for convenience in exposition,

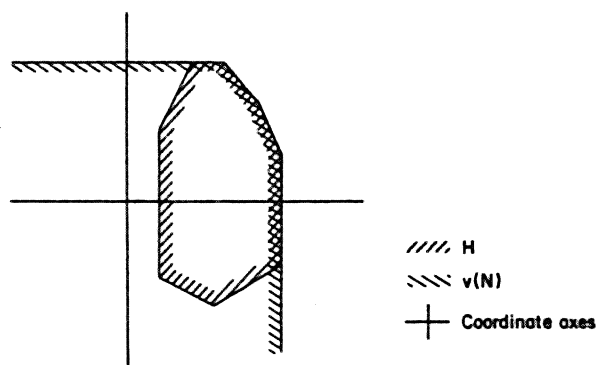

FIGURE 3

and so for many of the theorems they are stronger than necessary. The reader is referred to the original papers for statements of alternative conditions under which the various theorems hold.

In the N-M theory, various kinds of payoff vectors are distinguished according to their "rationality" attributes. A payoff vector is said to be *individually rational* if each player gets at least what he can guarantee himself, and *group rational* if the whole group cannot play in such a way that each player gets more. The same notions can be defined in our context; precisely, x is individually rational if for each player i , we have $x^i \geq \max v(\{i\})$; and x is group rational if there is no payoff vector $y \in v(N)$ such that $y > x$. Let us denote by H_{ig} , H_i , and H_g the subsets of H obtained by imposing individual and group rationality in various combinations; these sets, together with H , correspond to the sets of payoff vectors that have been studied in the N-M theory [39, 50]. In particular H_{ig} corresponds to what is usually called the set of "imputations."

Note that the characteristic function $v(S)$ does not necessarily have to be interpreted as the set of payoff vectors that S can *assure* itself; if preferred, it may be interpreted in any other way, such as what a coalition "thinks it can get." It is also possible that a game is given *a priori* in characteristic function form, like the following voting game:

Let the number of players be odd, and let C be a convex compact subset of E^N . The game consists of the players "voting" for a member of C by majority rule. If a majority agrees on a point x of C , then x is the payoff vector (to all players); otherwise each player i gets only his personal minimum m^i in C , i.e. $\min \{x^i : x \in C\}$. It is easy to see how this can be generalized to weighted majority games and to simple games in general.

To describe the characteristic function, let C^S denote the projection of C on E^S , and let m^S denote the S -vector $\{m^i\}_{i \in S}$. Then

$$v(S) = \begin{cases} \text{(if } S \text{ is winning) the set of all } S\text{-vectors that} \\ \text{are } \leq \text{ a member of } C^S; \\ \text{(if } S \text{ is losing) the set of all } S\text{-vectors that} \\ \text{are } \leq m^S. \end{cases}$$

4. THE VON NEUMANN-MORGENSTERN SOLUTION

We can now develop a theory of games parallel to the N-M theory. The two most important elements of that theory are the solution and the core. First, we define domination:

Let $x, y \in E^N$, and let x^S denote the projection of x on E^S . Then

$$\begin{aligned} x >_S y &\Leftrightarrow_{df} x^S \in v(S), x^S > y^S \\ x > y &\Leftrightarrow_{df} x >_S y \text{ for some } S. \end{aligned}$$

Let $K \subset E^N$. Just as in the N-M theory, a *solution* of K is a subset V of K such that no two members of K dominate each other, and every member of K not in V is dominated by some member of V . The *core* of K (denoted by $C(K)$) is the set of members of K not dominated by other members of K .

THEOREM 1. *A solution of H_i is a solution of H_{i_0} , and conversely.*

This corresponds to a theorem in the N-M theory first proved by Shapley [50]. The proof, which is not difficult, is given in [23]. Henceforth a *solution of a game* is a solution of H_{i_0} for that game.

THEOREM 2. *Every 2-person game has a unique solution, namely all of H_{i_0} . This is also the core of H_{i_0} .*

This too is easy to prove. The first difficult theorem is:

THEOREM 3. *Every 3-person 0-sum game has a solution.*

A 3-person 0-sum game is one in which H is contained in the hyperplane $\sum_{i=1}^3 x^i = 0$. Theorem 3 is proved in Peleg [23]. The 0-sum restriction may seem somewhat strange in a non-side-payment context; however, it makes sense if one assumes that the payoff to a game is in money, that no money enters or leaves the game from outside, that chance and mixed strategies are irrelevant, and that side payments, though obviously possible, are illegal. In addition, the proof was a considerable technical achievement, and pointed the way to the subsequent:

THEOREM 4. *Every 3-person game for which H is a polyhedron has a solution.*

This is proved in Stearns [30]. In the same place Stearns classifies all solutions to 3-person games.

The biggest problem left open by von Neumann and Morgenstern in their book [45] was that of the existence of a solution for an arbitrary n -person cooperative game with side payments and transferable utility. The problem remains unsolved to this day. One of the methods they used to attack this problem [45, pp. 266-271 and pp. 587-603] was to define the notion of solution for an abstract relation defined on an abstract set (abstracting from the game situation, where it is defined for the domination relation on the set of imputations). They then studied the solution notion in this abstract framework, seeking conditions of a general nature that would ensure the existence of a solution and that would be satisfied in the game context. This work was carried on by Richardson and others (see for example [40, 47]), but though many interesting sufficient conditions for existence were found, none could be proved to apply to the game context. In 1959, Kalisch and Nering [41] constructed a game with a countable infinity of players and showed that it has no solution, thus showing that the completely "abstract" approach to proving the existence theorem could not work. However, the imputation space in the Kalisch-Nering example

is not compact. Thus there remained the hope that a “modified abstract” approach could be made to work, in which account would be taken of topological properties of the imputation space and the domination relation. This hope has recently been shattered by Stearns (unpublished³), who proved:

THEOREM 5. *There is a 7-person game with no solution.*

The original problem proposed by von Neumann and Morgenstern—for games with side payments and transferable utility—remains open.

We mention that it is possible to construct a theory of composition of games that parallels the N-M theory, but that yields simpler and more intuitive results [3, 5, 7].

Isbell [16] has constructed a theory of cooperative games without side payments in which he makes use of the notion of N-M solution. However, his work is not based on the characteristic function model presented in §3.

5. THE CORE

Let $K \subset E^N$. The *Core* of K (denoted by $C(K)$) is the set of members of K not dominated by other members of K .

THEOREM 6. *Assume either that H is a convex compact polyhedron, or that $H = v(N)$. Then $C(H) = C(H_i) = C(H_g) = C(H_{ig})$.*

In other words, all the “interesting” cores are equal, so we are justified in referring to the “core of a game.” This is trivial in the N-M theory, but no longer so in the current theory. Under the first of the two assumptions, the proof was first published in [3]; subsequently it was considerably simplified by Stearns (unpublished). We sketch the simplified proof here.

The difficult part is to prove that imposing group rationality, either on H or on H_i , does not change the core. For example, take H ; we must prove that $C(H) = C(H_g)$. $C(H) \subset C(H_g)$ is easily established. The crux of the proof is the opposite inclusion. For $x \in E^N$, denote $\max_i |x^i|$ by $\|x\|$. We need the following

LEMMA. *There is a positive number M (depending on H only) such that for all $z \in H - H_g$, there is a $\hat{z} \in H_g$ such that $\hat{z} > z$ and for each $i \in N$, $\hat{z}^i - z^i > \|z - \hat{z}\|/M$.*

In words, the lemma states that for each z in H that is not already in the top of H , we can find a ray that leads to the top of H , and that is increasing in all coordinates at a rate that is uniformly (i.e., independently of z) bounded away from 0. The lemma is true only because H is a polyhedron; for example, in Figure 4, as the points z approach the x^1 -axis, the rate of increase of x^1 along the dotted lines tends to 0. Indeed, there are counter-examples to Theorem 5 if it is not assumed that H is a

³ A previous published version [31] has the disadvantage that some of the $v(S)$ are empty.

polyhedron [3]. The proof of our lemma is given in [3], and will not be repeated here.

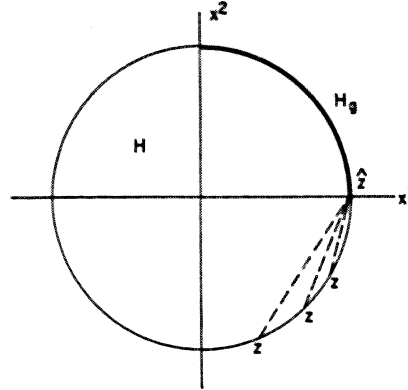

FIGURE 4

Let $x \in C(H_g)$. We will suppose that $x \notin C(H)$, i.e., x is dominated via some S by an element y of H , and will then construct an element \hat{z} of H_g which also dominates x ; this will be a contradiction. Roughly, this is done by taking an element z very close to x on the line segment \overline{xy} which joins x and y , and constructing the corresponding \hat{z} . Now either

- i) \hat{z} is far from z , or
- ii) \hat{z} is close to z .

In the first case, it follows from the lemma that all the coordinates of \hat{z} must be considerably greater than those of z ; since z is close to x , it follows that $\hat{z} > x$, contradicting $x \in H_g$. In the second case, it follows that \hat{z} is close to x . Hence from $y >_S x$ we deduce that $y >_S \hat{z}$, and hence it follows that $\hat{z}^S \in v(S)$ (from property (2) of the characteristic function). But $\hat{z}^S > z^S > x^S$, and therefore $\hat{z} >_S x$, which gives us the desired contradiction.

More precisely, we suppose without loss of generality that $x = 0$. Let $\sigma = \min_{i \in S} y^i$, where $y >_S x$. Let $z \in \overline{yx}$ be such that $|z| < \delta/(M+1)$. Then $\hat{z}^i - z^i > \|\hat{z} - z\|/M$ for all i . Hence if $\|\hat{z} - z\| \geq \delta M/(M+1)$, then $\hat{z}^i - z^i > \delta/(M+1)$. Then

$$\hat{z}^i = \hat{z}^i - z^i + z^i \geq \hat{z}^i - z^i - \|z\| > \delta/(M+1) - \frac{\delta}{(M+1)} = 0,$$

contradicting $0 \in H_g$. Hence $\|\hat{z} - z\| < \delta M/(M+1)$. Hence for all i , $\hat{z}^i = \hat{z}^i - z^i + z^i \leq \|\hat{z} - z\| + \|z\| < \delta M/(M+1) + \delta/(M+1) = \delta$. Hence for $i \in S$, $\hat{z}^i - y^i \leq \max_i \hat{z}^i - \min_i y^i < \delta - \delta = 0$. Hence $\hat{z}^S < y^S$. Hence $\hat{z}^S \in v(S)$, and $\hat{z} >_S x$, contradicting $x \in C(H_g)$.

Under the second of the two assumptions, Theorem 6 was proved by Burger [7]; the proof is simpler than under the first assumption. Burger's

paper is the first to make systematic use of the assumption $H = v(N)$; this makes for a considerably simpler theory.

When is the core of a game non-empty? In the N-M case, a necessary and sufficient condition for the non-emptiness of the core has been given by Shapley [51], in terms of "balanced" collections of coalitions. A similar condition has been given (independently) by Bondareva [35]. Using this notion of balanced collections, Scarf [27] recently obtained a sufficient condition for the non-emptiness of the core in the no-side-payment case as well.

For each $S \subset N$, define a vector e_S in E^N by

$$e_S^i = \begin{cases} 1 & \text{if } i \in S; \\ 0 & \text{if } i \notin S. \end{cases}$$

A collection \mathcal{S} of subsets S of N is called *balanced* if it is possible to assign to each S in \mathcal{S} a non-negative number δ_S , such that

$$\sum_{S \in \mathcal{S}} \delta_S e_S = e_N.$$

For example, if $N = \{1, 2, 3\}$, then $\mathcal{S} = \{\{1, 2\}, \{2, 3\}, \{1, 3\}\}$ is balanced, where the δ_S are given by $\delta_{\{1,2\}} = \delta_{\{2,3\}} = \delta_{\{1,3\}} = \frac{1}{2}$.

Scarf's theorem may now be stated as follows:

THEOREM 7. *Let $H = v(N)$. Assume that for every balanced collection \mathcal{S} of subsets of N , we have*

$$\bigcap_{S \in \mathcal{S}} (v(S) \times E^{N-S}) \subset v(N).$$

Then the core is non-empty.

The importance of this theorem may be illustrated by the fact that it implies the existence of a competitive equilibrium in a market (cf. §8); since the proof of Theorem 7 is "elementary" in the sense that it does not involve fixed point theorems, it follows that the existence of competitive equilibria may also be given an "elementary" proof.

6. VALUE

To motivate the notion of "value" as used in game theory, we can do no better than quote Shapley [49]: "At the foundation of the theory of games is the assumption that the players of a game can evaluate, in their utility scales, every 'prospect' that might arise as a result of a play. . . . One would normally expect to be permitted to include, in the class of 'prospects,' the prospect of having to play a game. The possibility of evaluating games is therefore of critical importance."

The value problem has been treated for games with side payments and

transferable utility (the N-M case) by Shapley [49] and Selten [48], and in the no-side-payment case by Nash [21, 22], Harsanyi [9, 11, 12], Isbell [17], Miyasawa [20], and Shapley [28]. In all treatments the value assigns to each game one (or sometimes more than one) payoff vector. Often the treatment proceeds from the normal rather than the characteristic function form, and in at least one case [48] it proceeds direct from the extensive form. Here we will confine ourselves to discussing the Shapley value, for games in characteristic function form.

The Shapley value was defined for the N-M case in [49], as an imputation satisfying a certain set of axioms. It was proved to be unique, and was shown to have the following probabilistic interpretation: The Shapley value of player i is the expected value of the random variable $f(S \cup \{i\}) - f(S)$, where S is the set of players "before" i in a random ordering of all the players, and f is the N-M characteristic function. This definition clearly depends on a numerical value for f , and it is not at all clear how it can be generalized to a no-side-payment characteristic function as defined in §3.

Very recently Shapley [28] succeeded in giving an elegant definition of his values in the no-side-payment case by means of a reduction to the N-M case. His procedure is as follows: Let us be given a no-side-payment game with characteristic function v , and let us *imagine* what would happen if we were to allow side payments. We would then obtain an N-M game, and this would have a Shapley value, say $w = (w^1, \dots, w^n)$. If it happens that $w \in v(N)$, i.e., that the players can attain w without actually making side payments, then w would be an excellent candidate for the Shapley value of the original game. Suppose that we now re-scale the original game, i.e., multiply the payoff of each player i by some non-negative constant p^i , and *then* allow side payments. We would then obtain another N-M game (generally different from the one discussed above), and this too would have a Shapley value. Shapley proved that for an appropriate choice of the scaling factors p^i , the Shapley value of the resulting N-M game is attainable by the players in the original (but re-scaled) no-side-payment game without actually making side payments. The scaling factors can then be eliminated and a Shapley value for the original (unscaled and no-side-payment) game results. We use the indefinite article advisedly; the value is no longer unique, because a number of different sets of scaling factors may yield attainable outcomes.

To simplify the formal description, we adopt the convention that if x and y are vectors, then xy denotes the vector whose i th coordinate is $x^i y^i$. For each vector $p \geq 0$, define a characteristic function v_p from the given one v by

$$v_p(S) = \{y \in E^S : \text{there is an } x \in v(S) \text{ such that } y \leq p^S x\}.$$

It may be verified that v_p satisfies the axioms for a characteristic function.

Now define an N-M characteristic function f_p by

$$f_p(S) = \max \left\{ \sum_{i \in S} y^i : y \in v_p(S) \right\}; \quad (5)$$

it is not difficult to show, by using (4), that the maximum is attained. Let $w(p)$ be the Shapley value for f_p . Then a pair (p, w) is called a *valuation* of the original characteristic function v if $p \neq 0$, $w(p) = pw$, and $w \in v(N)$. Shapley's theorem is:

THEOREM 8. *Every game has a valuation.*

The first investigation of what amounts to a cooperative game without side payments is due to Nash [21]; Nash's "bargaining problem" is the same thing as a 2-person game in characteristic function form, in the sense of §3. Each such game has a unique valuation (p, w) , in which w is the Nash solution. Like the Nash solution in the 2-person case, the valuation in the general case is derivable from a small number of abstract axioms [28].

7. THE BARGAINING SET M_1^i

In the context of the bargaining set, the object of interest is not a payoff vector, but a *payoff configuration*, i.e., a pair consisting of a payoff vector and a coalition structure (partition of the players into disjoint coalitions). Furthermore the possibility that certain coalitions are "forbidden" (for example because of legal restrictions or communication difficulties) is admitted. For the N-M case, M_1^i is defined elsewhere in this volume [37] as a set of payoff configurations enjoying certain stability properties. Peleg [46] has proved that in the N-M case it is non-empty for each choice of a coalition structure, i.e., for each coalition structure there is a payoff vector such that the resulting pair is stable in the required sense. Unlike the situation for Shapley values, it is here quite easy to generalize the definition of M_1^i to the no-side-payment case, and in fact this can be done in two ways; the more appropriate of the two generalizations is denoted \tilde{M}_1^i . However, the existence theorem does not generalize.

THEOREM 9. *There is a 4-person game for which \tilde{M}_1^i is empty (for appropriate choice of coalition structure).*

The example is due to Peleg [24]. A positive result obtained by Peleg in the same paper is:

THEOREM 10. *In a game in which only 2-player coalitions are permitted, \tilde{M}_1^i is non-empty for each coalition structure.*

The proof makes use of the Eilenberg-Montgomery fixed-point theorem [38].

8. GAMES WITH SIDE PAYMENTS BUT WITHOUT TRANSFERABLE UTILITIES

Consider a game given by an N-M characteristic function f , i.e., a numerical function defined on the set of all subsets of N satisfying the

super-additivity condition

$$f(S \cup T) \geq f(S) + f(T) \quad \text{for } S \cap T = \phi.$$

Give this game the following interpretation: Each coalition S may go to a "referee" and receive exactly $f(S)$ dollars, on condition that it has agreed beforehand on how this money should be divided.

For each player i , let $u_i(b)$ be⁴ the utility of player i for b dollars, in the sense of N-M ([45, pp. 617–632]; also [19, pp. 12–38]). We will assume that u_i is bounded,⁵ continuous, and strictly increasing in b . Define a function u from E^N to itself by

$$u^i(x) = u_i(x^i) \quad (6)$$

for all $x \in E^N$ and $i \in N$. Let v' be the function defined on the subsets S of N by

$$v'(S) = \left\{ y \in E^S : \text{There is an } x \text{ in } E^N \text{ such that} \right. \\ \left. \sum_{i \in S} x^i = f(S) \text{ and } y \leq u^S(x) \right\}. \quad (7)$$

Intuitively, $v'(S)$ is the set of payoff vectors, *expressed in terms of utilities*, that are attainable by the coalition S . However, v' is not a characteristic function in the sense of §3, because $v'(S)$ may fail to be convex. We therefore replace $v'(S)$ by its convex hull; intuitively, this means that the coalition S will in general agree on a *lottery* that will determine the division of the $f(S)$ dollars, rather than agreeing on a specific division. We thus define a function v by

$$v(S) = \text{convex hull } v'(S). \quad (8)$$

Then v satisfies conditions (1)–(4) (where for convenience we take $H = v(N)$; it is of course neither compact nor polyhedral).

Suppose now that in the original game f , we exclude the possibility that the players will use lotteries to divide the payoffs. In that case the utility functions of the players become irrelevant, because their purpose is to represent preferences between *lotteries*. To represent preferences between actual sums of money (as distinguished from lotteries over such sums), utilities are not needed, as the dollar amount is a perfectly good measure for this purpose. And in fact, the reasoning leading to the N-M solution is then valid when the payoffs are expressed in money. Therefore we may calculate the N-M solutions (or the core, bargaining set, ψ -stable payoff configurations, and so on) of the characteristic function f as given, expressing the result in dollar terms, and the intuitive validity of the result is not

⁴ u_i is determined only up to an additive and a positive multiplicative constant. These constants may be chosen independently for the various players (indeed there is no meaningful way of correlating them).

⁵ The boundedness assumption is not strictly necessary but simplifies the discussion considerably; moreover it is intuitively very acceptable (cf. Isbell [16], p. 360).

based on any consideration of "linear utility," "transferable utility," "comparable utility," or indeed any utility whatsoever.

All this is based on the assumption that probabilistic considerations are for some reason excluded. If they are admitted, then utilities become relevant and indeed crucial; we must therefore replace the function f by the function v defined in (7) and (8), and use the corresponding definition of solution (§4). The question then arises: What is the relation, if any, between the solutions to f and the solutions to v ?

THEOREM 11. *If the utility functions u_i are concave, then a subset F of E^N is a solution to f if and only if $u(F)$ is a solution to v .*

Theorem 11 asserts that if the utility functions are concave, then the same utility distributions—and so also the same money distributions—result when the characteristic function of §3 is used rather than the original N-M characteristic function. It follows that for the validity of solution theory as described in [45] it is not necessary to assume that utilities are *linear* in money, as is usually supposed,⁶ but only that they are concave. The concavity assumption is an eminently reasonable one, and is often made in the literature.

The theorem is intuitively not surprising, because concave utilities mean that the players never prefer a gamble to its expectation, and hence the function v does not offer them different possibilities than the function f . The proof is very simple. From the concavity of the u_i it follows that $v' = v$, and hence u is a *domination-preserving* 1-1 correspondence from the space $I_{i\sigma}$ of imputations in the game f onto the corresponding space $H_{i\sigma}$ for v . Theorem 11 follows from this property of u .

It is rather curious that for simple games f (i.e., f taking the values 0 and 1 only), a result superficially similar to Theorem 11 holds in the diametrically opposed case, when the utility functions are all convex (i.e., the players always like a gamble at least as well as its expectation). Assume the utility functions are normalized so that $u_i(0) = 0$ and $u_i(1) = 1$. Then (in general) $u(I_{i\sigma}) \neq H_{i\sigma}$, and hence u does not provide a correspondence between $I_{i\sigma}$ and $H_{i\sigma}$; but $I_{i\sigma}$ and $H_{i\sigma}$ are formally equal, and the *identity* is a domination preserving 1-1 correspondence between them. Here again, the result is easy to understand intuitively: a coalition of these gamblers will never split the money, always preferring a lottery in which one member gets all with a certain probability; the probabilities in the solutions to v then correspond to sums of money in the solutions to f .

Is there *always* a domination-preserving 1-1 correspondence between $I_{i\sigma}$ and $H_{i\sigma}$? The answer is no. Consider the 3-person simple majority game ($f(S) = 0$ or 1 according as S has one or more members). Let the utility functions be the piecewise linear functions graphed in Figure 5.

⁶ cf. the quotation from Luce and Raiffa in §2.

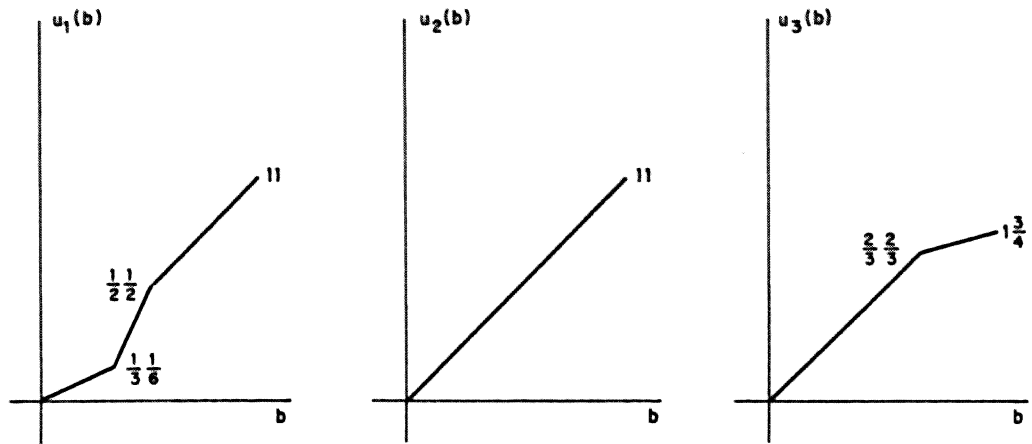

FIGURE 5

H_{i_0} is pictured in Figure 6. A 1-1 domination-preserving mapping from H_{i_0} onto I_{i_0} would have to take both the points $(\frac{1}{6}, \frac{1}{3}, \frac{1}{2})$ and $(\frac{1}{4}, \frac{1}{4}, \frac{1}{2})$ of H_{i_0} onto the point $(\frac{1}{4}, \frac{1}{4}, \frac{1}{2})$ of I_{i_0} , an absurdity (parentheses and commas are omitted in the figures and henceforth in the text).

We close this section with an example of what happens when a pessimist (concave utility) plays a simple majority game with two optimists (convex

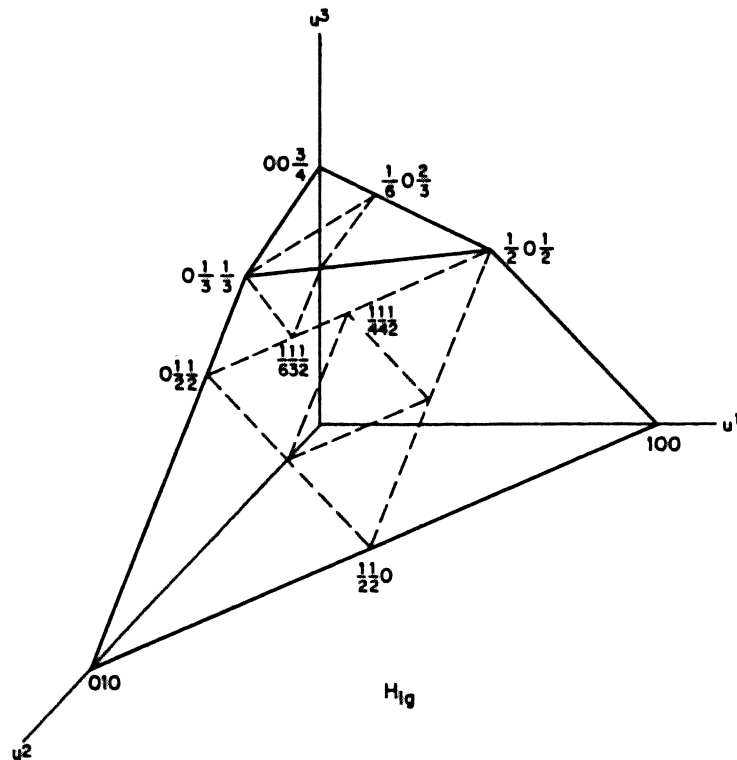

FIGURE 6, PART I

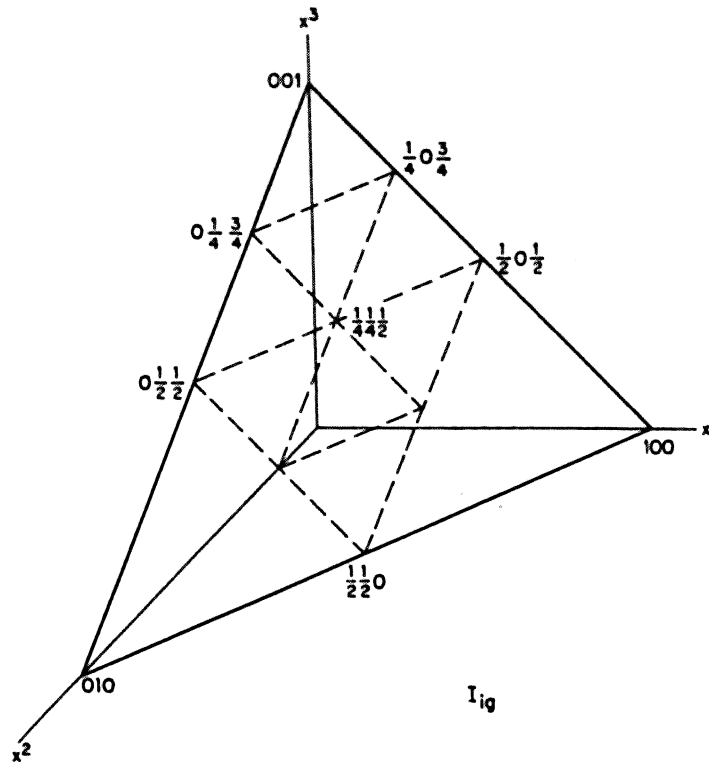

FIGURE 6, PART II

utility). Let f be as in the previous paragraph, and let the utility functions be as graphed in Figure 7. The 3-point solution of f is $\frac{1}{2}\frac{1}{2}0$, $\frac{1}{2}0\frac{1}{2}$, $0\frac{1}{2}\frac{1}{2}$, it being understood that the coordinates of the vectors in the solution are expressed in dollars. This solution applies when lotteries are excluded. When lotteries are admitted, we must pass from f to v . $u(I_{ig})$ is pictured in Figure 8; it may be seen that H_{ig} is formally equal to I_{ig} . Hence v also has the 3-point solution $\frac{1}{2}\frac{1}{2}0$, $\frac{1}{2}0\frac{1}{2}$, $0\frac{1}{2}\frac{1}{2}$, but this time the coordinates of the

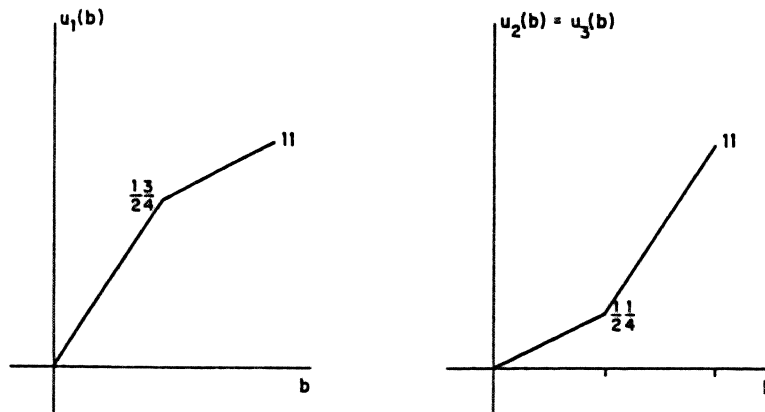

FIGURE 7

vectors are expressed in utility units rather than in dollars. If we translate back into dollars, we find that the solution is $\frac{1}{4}\frac{3}{4}0$, $\frac{1}{4}0\frac{3}{4}$, $0\frac{3}{4}\frac{3}{4}$. The point $0\frac{3}{4}\frac{3}{4}$ cannot be attained by a distribution of money, but is attained by a $\frac{1}{2}$ - $\frac{1}{2}$ lottery for $f(23)$ between players 2 and 3. However, $\frac{1}{4}\frac{3}{4}0$ is attainable by a distribution of the sum $f(12)$, without recourse to lotteries. It follows that if the coalition 12—consisting of the pessimist and an optimist—forms,

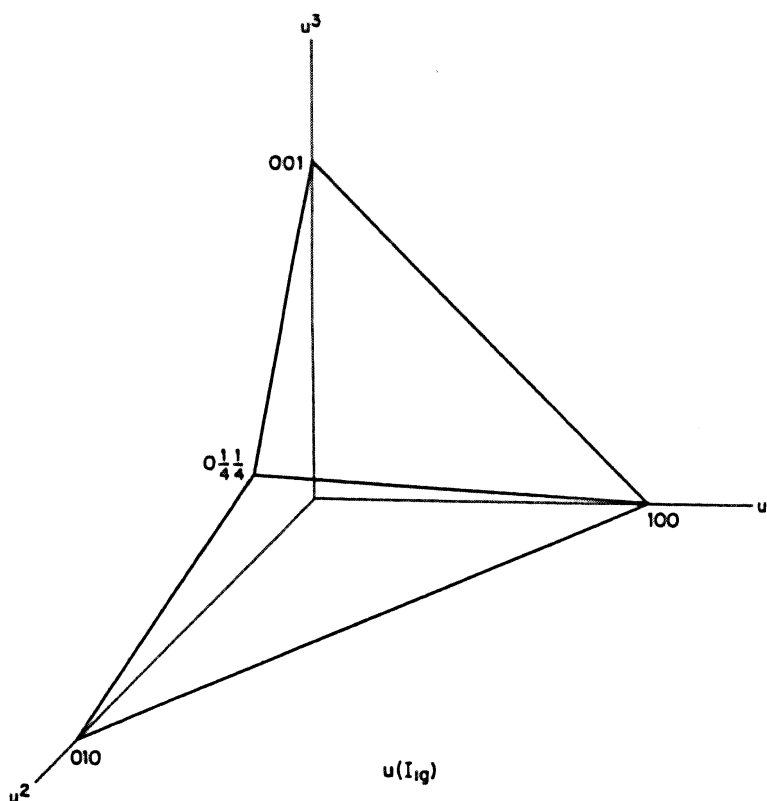

FIGURE 8

then the willingness of the optimist to take risks puts the pessimist at a very considerable material disadvantage, even though in the end no risks are taken by either player.

If all the points of the solution of v had been attainable without recourse to lotteries, then this phenomenon would not have occurred. This follows from the fact that in an arbitrary n -person game, if a solution V of v is included in $u(I_{12})$, then $u^{-1}(V)$ solves f . The proof is an easy consequence of Theorem 1.

The results of this section, hitherto unpublished, are the outcome of conversations between M. Maschler and the author. Though they are not deep, they shed light on the relation between utilities and n -person games.

9. MARKET GAMES

Recently a good deal of attention has been paid to market games, which are in fact cooperative games without side payments, essentially in characteristic function form. The game-theoretic tool most significant in this connection is the core; it has been shown that for markets with "many" traders (this notion has been formalized in a number of different ways) the notion of core is essentially equivalent to that of Walrasian "competitive equilibrium." Under certain conditions it appears that Shapley's valuation (see §6) is closely connected with the competitive equilibrium as well. Finally, Scarf's core-theorem (Theorem 7) yields the non-emptiness of the core of a market game under wide conditions, and by using this an "elementary" existence proof for the competitive equilibrium can be obtained. For details, the reader is referred to the original papers (Debreu and Scarf [8], Aumann [4, 34], Vind [32], Shapley [28], Scarf [27]).

10. THE NORMAL FORM

The passage from the normal to the characteristic function form is not without its pitfalls. Even in the case of games with side payments and transferable utility (the N-M case), it is not generally agreed that the characteristic function as derived from the normal form by von Neumann and Morgenstern adequately represents the game; this is chiefly because for games that are not constant-sum, it does not always take adequate account of threats. Nevertheless the N-M definition is useful for some purposes, and we now examine how it can be generalized to the no-side-payment game.

In the N-M case, if f is the characteristic function and S is a coalition, then $f(S)$ is the maximum amount that S can guarantee itself; by the minimax theorem $N - S$ can prevent S from getting more. Here these two approaches—what S can guarantee itself, and what $N - S$ can prevent—are no longer equivalent. We write down definitions corresponding to both approaches.⁷

$v_{\alpha}(S)$ = the set of all payoff S -vectors x such that S
can guarantee that it will get at least x .

$v_{\beta}(S)$ = the set of all payoff S -vectors x such that $N - S$
cannot prevent S from getting at least x .

By "getting at least x " we mean getting an amount that is at least x^i for each player i ; and by "can guarantee" or "can prevent" we mean the existence of a single (correlated) strategy that guarantees or prevents, independent of the actions of the other players.

⁷ These definitions were first explicitly given in [5].

When side payments are allowed,

$$v_\alpha(S) = v_\beta(S) = \left\{ x \in E^S : \sum_i x^i \leq f(S) \right\},$$

where $f(S)$ is the N-M value of S . That v_α and v_β are in general different is seen by means of the 3-person game,⁸

1, -1	0, 0
0, 0	-1, 1

where the rows represent strategies of the coalition $\{1, 2\}$, the columns represent strategies of player 3, and the entries are payoff $\{1, 2\}$ -vectors (the payoffs to player 3 are irrelevant). A picture of $v_\alpha(\{1, 2\})$ and $v_\beta(\{1, 2\})$ is given in Figure 9.

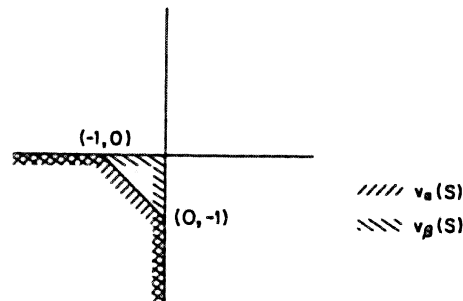

FIGURE 9

Whether the α -notion or the β -notion is preferable is a matter of taste. Both satisfy the axioms for characteristic functions [3]; that is an advantage of the axiomatic treatment. The α -notion seems to be intuitively more appealing, but as we shall see the β -notion has a certain technical advantage.

Some authors have considered the discrepancy between $v_\alpha(S)$ and $v_\beta(S)$ to be a disturbing phenomenon. We noted above that $v_\alpha(S) = v_\beta(S)$ for games with transferable utility side payments. Jentzsch [18] has investigated the possibility of obtaining a wider class of games with the same property. The general tenor of his result is negative, i.e., v_α and v_β cannot be expected to coincide unless one is talking about games that to start with are very similar to games with transferable utility side payments. To give a more precise description of his result, let us for the moment fix attention on a single coalition S . If we are interested in this coalition only, then in the (transferable utility) side-payment case we can substitute the following "adjusted normal form" for the usual, normal form: The "adjusted normal form" is a matrix whose rows are pure strategies of S ,

⁸ See Jentzsch [18] and Aumann [3].

whose columns are pure strategies of $N - S$, and whose entries are the total payoff to S for the appropriate strategy n -tuples. What this really means is that after S and $N - S$ have chosen strategies, S can pick any vector whose sum does not exceed the entry (the redistribution is made possible by the side payments). Use of mixed (i.e., correlated) strategies on the parts of S and $N - S$ will yield a numerical payoff for S which is the appropriate mixture of the pure payoffs, and which S can also allocate between its members as it sees fit. It is exactly the "value" of this adjusted normal form, when considered as a 2-person 0-sum game, that gives the N-M characteristic function $f(S)$.

The adjusted normal form can be generalized to cover games with non-transferable utility side payments. Suppose that a pair (p, q) of strategies (of S and $N - S$) yields a payoff S -vector x . By the use of side payments, S can redistribute the income from x among its members, but because utility is not assumed to be transferable, total utility will not be conserved in the redistribution. The set of all payoff S -vectors that can be obtained from x by means of redistributions of this kind will be a subset of E^S that satisfies conditions (1) and (2) for characteristic functions (closedness, convexity, unboundedness towards the southwest); such subsets of E^S will be called S -catalogues, or simply *catalogues*.⁹ The adjusted normal form for games with nontransferable utility side payments is thus a matrix whose entries are catalogues rather than numbers. As in the previous case, it is possible to consider mixed outcomes, corresponding to mixed strategies: a mixture of two catalogues (with specified probabilities) is simply the set of mixtures of its members (with the same probabilities), and is itself a catalogue.

If we now restrict the catalogues in the entries to be half-spaces of the form $\sum x^i \leq k$, then we are back in the transferable utility case, and it follows that $v_\alpha(S) = v_\beta(S)$. Jentzsch asked whether we could not still assure $v_\alpha(S) = v_\beta(S)$ by imposing a weaker restriction on the catalogues that appear in the adjusted normal form. More precisely, consider a family \mathcal{F} of S -catalogues; let us call a game *adjusted to \mathcal{F}* if in its adjusted normal form, all payoffs—including the mixed ones—are in \mathcal{F} . Then what conditions must be placed on \mathcal{F} in order to ensure that for every game that is adjusted to \mathcal{F} , we have $v_\alpha(S) = v_\beta(S)$?

Let us call an \mathcal{F} for which this holds *determinate*. Jentzsch showed that the condition of being determinate is a very strong one:

THEOREM 12. *Let us call a catalogue F regular if it has a supporting hyperplane in each positive direction,¹⁰ and assume that every member of*

⁹ Presumably because you can pick from them whatever you want.

¹⁰ I.e., for each vector x with positive coordinates, there is a hyperplane that supports \mathcal{F} and is perpendicular to x . Figure 2 illustrates a regular catalogue, and Figure 1 illustrates one that is not regular.

\mathcal{F} is regular. If \mathcal{F} is determinate, then of every three members of \mathcal{F} , one is a probability mixture of the other two (and in particular lies between the other two).

The theorem does not apply directly to the N-M case, because half-spaces are not regular. But in all practical cases side payments are limited, and this makes the catalogues regular and the theorem applicable.

Since the motivation for this work derives from an analysis of games with side payments but without transferable utility, it is natural to ask for conditions on the utility functions u_i of the players i in S that will lead to games for which¹¹ $v_\alpha(S) = v_\beta(S)$. Suppose, for example, that the utility function of each player for a (positive) amount of money b is that suggested by Bernoulli, namely $\log b$. Then if S has a total amount of money d to divide between its members (d positive), the resulting catalogue is

$$\{y \in E^S : \sum_{i \in S} \exp(y^i) \leq d\},$$

where \exp is the exponential function ($\exp(b) = e^b$). Jentzsch remarked that it can be shown from his results that the family of all such catalogues, as d varies, is determinate. This means that in side-payment games played by players all of whom have the utility function $\log b$, we have $v_\alpha(S) = v_\beta(S)$.

What other S -tuples of utility functions have this property? This question was answered by B. Peleg in [25]. It turns out that there are very few of them. His chief result is as follows: Suppose that the utility functions of the players i in S are concave and have the property that $v_\alpha(S) = v_\beta(S)$ in any game in which these players participate, providing that the players all have personal minima of 0 (i.e., $v_\alpha(\{i\}) = v_\beta(\{i\}) = (-\infty, 0]$). Then either $u_i(b) = \log b$ for all i in S , or there is a λ obeying $0 < \lambda \leq 1$ such that for all i in S , $u_i(b) = b^\lambda$, or there is a λ obeying $\lambda < 0$ such that for all i in S , $u_i(b) = -b^\lambda$. This underscores the fact that equivalence between the α - and the β -notions is a very rare event.

The concepts we have described may be applied to supergames, i.e., long sequences of plays of a cooperative game without side payments. We look for stable behavior in such games. There are two ways of approaching this problem. One is to treat the entire supergame as a single game, and use stability criteria appropriate for a single game. The other way is to speculate as to what kind of behavior in the individual plays constituting the supergame would lead to stability in the long run. Now if we are going to follow the first method, then one of the concepts we could use would be Nash's equilibrium point [44]. Recall that this is a strategy n -tuple, or

¹¹ This question is not connected with that investigated in §6, where the characteristic function was given and there was no question of mixed strategies and of the difference between v_α and v_β .

“point,” such that no individual can gain by deviating from it, while the others retain the same strategies they were previously using. Since we are discussing cooperative games, it would be more appropriate to consider a point such that no *coalition* can gain by deviating from it while the others retain the same strategies. Let us call such a point a *strong equilibrium point*.

Let us now try the other approach. If a coalition is expecting more plays, then the question of whether it can improve its lot for fixed strategies of the other players becomes irrelevant, because the other players will not keep their strategies fixed, but will take counteraction on subsequent plays. The question is: when can a coalition be *sure* of a higher payoff? Obviously some kind of core notion is involved here; the surprising fact is that it is not the core according to the α -notion but rather according to the β -notion.

THEOREM¹² 13. *The β -core of a game coincides with the set of payoff vectors to strong equilibrium points in its supergame.*

This is the “technical advantage” of the β -notion to which we previously referred.

We outline the proof of this theorem. For this purpose we should first define the payoff in the supergame. But the precise definition is complicated and not important at the moment; the general idea is that the payoff to a superplay is some kind of average of the payoffs to the individual plays, and this is all that we shall need.

First suppose that x is in the β -core of the game (because of Theorem 5 we do not have to specify which one of the β -cores). We will build a strong equilibrium point whose payoff is x . Now it is possible to prove¹³ from the definition of v_β and with a little fussing that to say $x \in \beta$ -core is equivalent to saying that *each coalition can prevent its complement from getting more than it (the complement) does at x .*

This being the case, let us construct a strong equilibrium point as follows: First find a correlated strategy n -tuple whose payoff is x ; call this c^N . Next, for each coalition S , let c^S be a correlated strategy for S that prevents the complement of S from obtaining more than it does at x . Now each player adopts the following strategy in the supergame: He starts out by proposing c^N for the first play, and continues to propose this, play after play, as long as the other players agree. If, however, there is a set of players that disagree—let us call them “disloyal” players—then our player will propose c^S , where S is the set of loyal players. Once a player has become disloyal, he will no longer be accepted in the set of loyal players. The result is that if everybody plays along with this equilibrium point, then x is the result, but if some set of players does not, then eventually

¹² First proved in [1]. For a description that is more precise than the present one and more readable than that of [1], see the end of [3]; but no proof is sketched there.

¹³ Cf. Lemma 9.1, p. 304 of [1].

each of its members will be found in the disloyal set; from then on all the loyal players S will be playing c^S against the disloyal players, and by the definition of c^S at least one disloyal player i will get no more than x^i . This shows (modulo some glossed-over difficulties) that the β -core is a subset of the strong equilibrium payoffs.

Conversely, suppose that x is *not* in the β -core; then it is β -dominated. This means that there is a coalition S and a $y \in E^S$ such that $N - S$ cannot prevent S from getting y , and $y > x^S$. Suppose there were a strong equilibrium point f in the supergame whose payoff is x . Let f^{N-S} denote the part that $N - S$ has in f , i.e., an $(N - S)$ -tuple of strategies in the supergame, one for each member of $N - S$. On the first play f^{N-S} dictates a certain set of strategies in $N - S$. For this set of strategies, there exists a strategy for S which yields at least y (this is what is meant by saying that $N - S$ cannot prevent S from getting at least y). On the second play, f^{N-S} again dictates a strategy set for $N - S$, based on the history of the previous play. For this strategy, there again exists a strategy for S that yields at least y ; it may be different from the strategy of S on the first play. We can continue in this way; no matter what f^{N-S} dictates, there exists a strategy for S that yields at least y on every play. Since $y > x^S$, this shows that by deviating from f , S can gain, so f cannot be a strong equilibrium point.

This last part of the proof has a curious flavor, because of course S cannot know which supergame strategy $N - S$ is using. However, it does definitely prove that f cannot be in equilibrium, which really involves nobody wanting to deviate even if he knows what the others are playing. Theorem 13 is related to Blackwell's work on games with vector payoffs [6].

The Zermelo-von Neumann-Kuhn theorem about pure-strategy equilibrium points in games of perfect information has the following analogue for supergames of cooperative games with side payments.

THEOREM 14. *If the supergame of a game of perfect information has any strong equilibrium points at all, then it also has strong equilibrium points which involve only pure strategies.*¹⁴

In §6, we discussed the close connection between no-side-payment characteristic functions and Nash's bargaining problem [21], and pointed out that Shapley's valuation generalizes Nash's solution to the bargaining problem. Nash followed up the work in [21] by a paper on 2-person games in normal form [22], for which he proposed a "value" taking threat possibilities into account. This work was generalized by Raiffa in [26], but he too treated only 2-person games. The problem of defining a value for n -person games (both with and without side payments) that will take threats into account has been treated by several authors (cf. §6). Isbell [16] has constructed a theory of games without side payments that parallels the N-M solution theory but takes threat possibilities into account.

¹⁴ For the precise statement and proof see [2].

11. HISTORICAL REMARKS

Shapley and Shubik [29] were the first to suggest that N-M solutions could be defined even in the absence of a transferable utility. Their definition of dominance is very similar to ours; but rather than explicitly using a characteristic function, it depends directly on the α -notion. Shapley and Shubik imply that they must have (nontransferable utility) side payments to make their definition work, but actually it is perfectly general. They proved no theorems, confining themselves to general definitions.

Luce and Raiffa [19, p. 234] also gave a definition of dominance and solution for cooperative games without side payments. Their definition has some restrictive and complicating features, which in the light of later work turn out to have been unnecessary. They, too, proved no theorems, mentioning that "next to nothing is known about these definitions."

Functions that are very similar in form to the characteristic functions of §3 were first described by Isbell [16, 17]. He called them *end-games*, and used them to characterize, for each given payoff vector, the redistributions of utility that are made possible by means of nontransferable utility side payments. This use is related to Jentzsch's catalogues rather than to the development of §3; the latter is due to Aumann and Peleg [5]. The form of v in this survey differs slightly from that in [5]; the $v(S)$ of [5] would be $v(S) \times E^{N-S}$ in the notation of this paper.

Other historical references may be found in the body of the paper.

12. A Bibliography of Cooperative Games Without Side Payments

- [1] R. J. Aumann, "Acceptable points in general cooperative n -person games," in [43], pp. 287–324 [Chapter 20].
- [2] —, "Acceptable points in games of perfect information," *Pac. J. Math.* 10 (1960), pp. 381–417 [Chapter 21].
- [3] —, "The core of a cooperative game without side payments," *Trans. Amer. Math. Soc.* 98 (1961), pp. 539–552 [Chapter 39].
- [4] —, "Markets with a continuum of traders," *Econometrica* 32 (1964), pp. 39–50 [Chapter 46].
- [5] R. J. Aumann and B. Peleg, "Von Neumann-Morgenstern solutions to cooperative games without side payments," *Bull. Amer. Math. Soc.* 66 (1960), pp. 173–179 [Chapter 38].
- [6] D. Blackwell, "An analog of the minimax theorem for vector payoffs," *Pac. J. Math.* 6 (1956), pp. 1–8.
- [7] E. Burger, "Bemerkungen zum Aumannschen Core-Theorem," *Zeitschrift für Wahrscheinlichkeitstheorie* 3 (1964), pp. 148–153.
- [8] G. Debreu and H. Scarf, "A limit theorem on the core of an economy," *Int. Econ. Rev.* 4 (1963), pp. 235–246.
- [9] J. C. Harsanyi, "A bargaining model for the cooperative n -person game," in [43], pp. 325–356.

- [10] —, "Measurement of social power in n -person reciprocal power situations," *Behavioral Science* 7 (1962), pp. 81–91.
- [11] —, "A simplified bargaining model for the n -person cooperative game," *Int. Econ. Rev.* 4 (1963), pp. 194–220.
- [12] —, "Approaches to the bargaining problem before and after the theory of games: a critical discussion of Zeuthen's, Hicks' and Nash's theories," *Econometrica* 24 (1956), pp. 144–157.
- [13] —, "On the rationality postulates underlying the theory of cooperative games," *J. Conflict Resolution* 5 (1961), pp. 179–196.
- [14] —, "Bargaining in ignorance of the opponent's utility function," *J. Conflict Resolution* 6 (1962), pp. 29–38.
- [15] —, "A bargaining model for social status in informal groups and formal organizations," *Behavioral Science* 11 (1966), pp. 357–369.
- [16] J. R. Isbell, "Absolute games," in [43], pp. 357–396.
- [17] —, "A modification of Harsanyi's bargaining model," *Bull. Amer. Math. Soc.* 66 (1960), pp. 70–73.
- [18] G. Jentzsch, "Some thoughts on the theory of cooperative games," in [36], pp. 407–442.
- [19] R. D. Luce and H. Raiffa, *Games and Decisions*, New York, John Wiley, 1957.
- [20] K. Miyasawa, "The n -person bargaining game," in [36], pp. 547–575.
- [21] J. F. Nash, "The bargaining problem," *Econometrica* 18 (1950), pp. 155–162.
- [22] —, "Two-person cooperative games," *Econometrica* 21 (1953), pp. 128–140.
- [23] B. Peleg, "Solutions to cooperative games without side payments," *Trans. Amer. Math. Soc.* 106 (1963), pp. 280–292.
- [24] —, "Bargaining sets of cooperative games without side payments," *Israel J. Math.* 1 (1963), pp. 197–200.
- [25] —, "Utility functions of money for clear games," *Nav. Res. Log. Quart.* 12 (1965), pp. 57–63.
- [26] H. Raiffa, "Arbitration schemes for generalized two-person games," in [42], pp. 361–387.
- [27] H. Scarf, "The core of an n -person game," *Econometrica* 35 (1967), pp. 50–69.
- [28] L. S. Shapley, "Values of large market games: Status of the problem," The RAND Corporation RM3957PR, February 1964.
- [29] L. S. Shapley and M. Shubik, "Solutions of n -person games with ordinal utilities" (abstract), *Econometrica* 21 (1953), p. 348.
- [30] R. Stearns, "Three-person cooperative games without side payments," in [36], pp. 377–406.
- [31] —, "On the axioms for a cooperative game without side payments," *Proc. Amer. Math. Soc.* 15 (1964), pp. 82–86.
- [32] K. Vind, "Edgeworth-allocations in an exchange economy with many traders," *Int. Econ. Rev.* 5 (1964), pp. 165–177.

Other References

- [33] R. J. Aumann, "Linearity of unrestrictedly transferable utilities," *Nav. Res. Log. Quart.* 7 (1960), pp. 281–284 [Chapter 16].
- [34] —, "Existence of competitive equilibria in markets with a continuum of traders," *Econometrica* 34 (1966), pp. 1–17 [Chapter 47].

- [35] O. Bondareva, "The core of an n -person game," *Vestnik Leningrad Univ.* 17 (1962), pp. 141–142.
- [36] M. Dresher, L. S. Shapley, and A. W. Tucker, editors, *Advances in Game Theory*, Ann. of Math. Study 52, Princeton, New Jersey, Princeton University Press, 1964.
- [37] M. Davis and M. Maschler, "Existence of stable payoff configurations for cooperative games," in M. Shubik, editor, *Essays in Mathematical Economics in Honor of Oskar Morgenstern*, Princeton, New Jersey, Princeton University Press, 1967, pp. 39–52.
- [38] S. Eilenberg and D. Montgomery, "Fixed point theorems for multi-valued transformations," *Amer. J. Math.* 68 (1946), pp. 214–222.
- [39] D. B. Gillies, "Solutions to general non-zero-sum games," in [43], pp. 47–85.
- [40] F. Harary and M. Richardson, "A matrix algorithm for solutions and r -bases of a finite irreflexive relation," *Nav. Res. Log. Quart.* 6 (1959), pp. 307–314.
- [41] G. K. Kalisch and E. D. Nering, "Countably infinitely many person games," in [43], pp. 43–45.
- [42] H. W. Kuhn and A. W. Tucker, editors, *Contributions to the Theory of Games II*, Ann. of Math. Study 28, Princeton, New Jersey, Princeton University Press, 1953.
- [43] R. D. Luce and A. W. Tucker, editors, *Contributions to the Theory of Games IV*, Ann. of Math. Study 40, Princeton, New Jersey, Princeton University Press, 1959.
- [44] J. F. Nash, "Non-cooperative games," *Ann. of Math.* 54 (1951), pp. 286–295.
- [45] J. von Neumann and O. Morgenstern, *Theory of Games and Economic Behavior*, Princeton, New Jersey, Princeton University Press, 1944, Third Edition rev., 1953.
- [46] B. Peleg, "Existence theorem for the bargaining set $M_1^{(i)}$," in M. Shubik, editor, *Essays in Mathematical Economics in Honor of Oskar Morgenstern*, Princeton, New Jersey, Princeton University Press, 1967, pp. 53–56; also, *Bull. Amer. Math. Soc.* 69 (1963), pp. 109–110.
- [47] M. Richardson, "Solutions of irreflexive relations," *Ann. of Math.* 58 (1953), pp. 573–590.
- [48] R. Selten, "Valuation of n -person games," in [36], pp. 577–626.
- [49] L. S. Shapley, "A value for n -person games," in [42], pp. 307–317.
- [50] —, "Notes on the n -person game III: Some variants of the von Neumann-Morgenstern definition of solution," The RAND Corporation, RM817, April 1952.
- [51] —, "On balanced sets and cores," *Nav. Res. Log. Quart.* 14 (1967), pp. 453–460.